

BEIJING HUADE HYDRAULIC INDUSTRIAL GROUP CO.,LTD.	Directional control valves Type WE 6...61B/... (new series)			RE 23188/12.2004
	Size 6	up to 35 MPa	up to 80L/min	Replaces: 23188/05.2001 RE: 23316/05.2001

Features:

- Direct solenoid actuated directional spool valve high performance version
- Wet pin DC or AC solenoids with removable coil
- Solenoid coil can be rotated through 90 °
- It is not necessary to open the pressure tight chamber when changing the coil
- Electrical connections either as individual or central connections
- Hand override, optional
- Porting pattern to Din 24 340 form A, ISO 4401 and CETOP-RP 121H

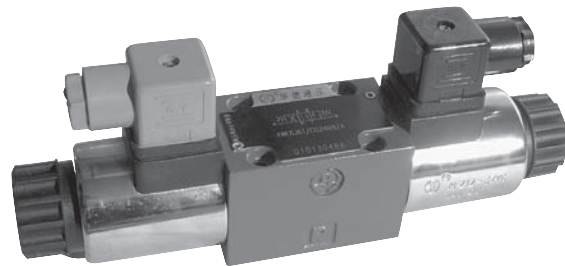

Function, section

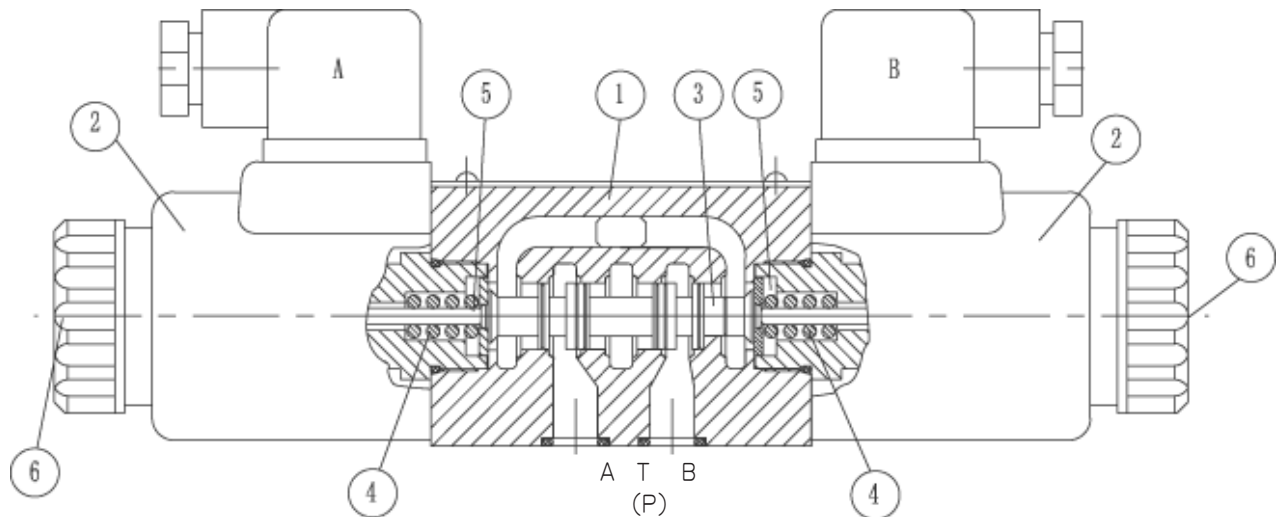

Type WE6...60B/

Essentially the directional control valves consist of housing (1), one or two solenoids (2), the control spool (3), and one or two return springs (4)

In the de-energized condition the control spool (3) is held in the neutral or initial position by means of return springs (4) (except for impulse spools). The control spool (3) is actuated via wet pin solenoids (2)

The force of the solenoids (2) acts via the plunger (5) on the control spool (3) and pushes this from its neutral position to the required end position. This gives free-flow

from P to A and B to T or P to B and A to T.

When solenoid (2) is de-energized, the control spool (3) is returned to its neutral position by means of the return springs (4).

An optional hand override (6), allows movement of the control spool (3) without energising the solenoid.

Ordering details.

		WE	6		61	B /	E					*
3 service ports = 3		Further details in clear text										
4 service ports = 4		No code = mineral oils										
Nominal size 6 = 6		V = phosphate ester										
Symbols see below		No code = Without cartridge throttle										
Series 60 to 69 = 61		B08 = Throttle Φ 0.8 mm										
(60 to 69: unchanged installation and connection dimensions)		B10 = Throttle Φ 1.0 mm										
Technology of Beijing Huade Hydraulic = B		B12 = Throttle Φ 1.2 mm										
Spring return = No code		Individual connections:										
Without spring return = O		K4= with component plug without plug-in connector										
Without spring return with detent = OF		Z4 = normal plug										
		Z5L = Large angled plug with indicator light										
		Central connections:										
		DKL = Central connection on cover with indicator light (without angled plug-in connector)										
High power solenoid = E		N9= With protected hand override (standard)										
Wet pin (oil immersed) with removable coil		N= With hand override										
		No code= Without hand override										
12 V DC = G12												
220 V AC 50 Hz = W220-50												
24 V DC = G24												
DC solenoid commuting automatically = W220R												

Symbols

= A
 = B
 = C
 = D
 = E
 = F
 = G
 = H
 = J
 = L
 = M
 = Y

1) Example: Spool E with switching position "a" ordering details..EA "b"

= .A 1)

= .B

Technical data

Hydraulic			
Max.operating pressure Ports A,B,P	(MPa)	up to 35.0	
Port T	(MPa)	21 (-);16 (~)	
		with symbols A and B,port T must be used as adrain port if the operating pressure is above the permitted tank pressure.	
Max.flow	(L/min)	80 (-);60 (~)	
Pressure fluid		mineral oil, phospate ester	
Viscosity range	(mm ² /s)	2.8 ~ 500	
Pressure fluid temperature range	(°C)	-30 ~ +80	
Degree of contamination		≤ 20(recommendation 10)	
Electrical			
Voltage type		DC	AC 50/60 Hz
Available voltages	(V)	12, 24, 42, 60, 96,	42, 110, 120, 230
		110, 180, 205, 220	50/60Hz
Power consumption	(W)	30	
Holding power	(VA)	-	50
Switch-on power	(VA)	-	220
Duty		continuous	continuous
Switching time to ISO 6403	ON	(ms)	25 to 45
	OFF	(ms)	10 to 25
Protection to DIN		IP 65	
Switching frequency	(cycles/h)	up to 15000	up to 7200
With electrical connections the protective conductor (PE) must be connected according to the relevant regulations.			

Characteristic curves (measured at $v = 41 \text{ mm}^2/\text{s}$ and $t = 50^\circ\text{C}$)

7 Symbol "R " in switched position A → B
 8 Symbols "G " and "T " in mid position P → T

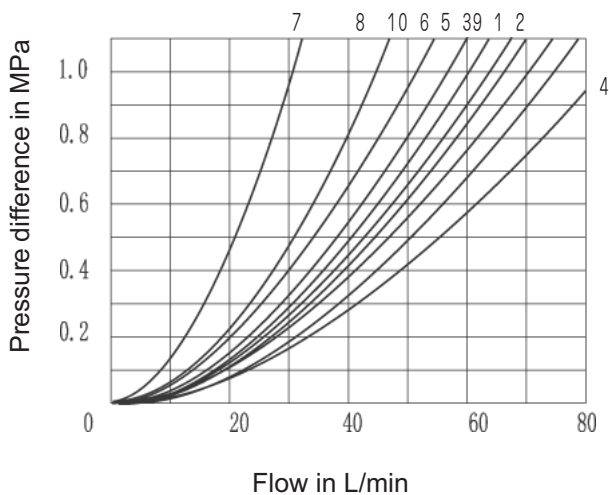

Symbols	Flow direction			
	P → A	P → B	A → T	B → T
A, B	3	3	-	-
C	1	1	3	1
D, Y	5	5	3	3
E	3	3	1	1
F	1	3	1	1
T, G	10	10	9	9
H	2	4	2	2
J, Q	1	1	2	1
L, U	3	3	4	9
M	2	3	3	3
P	3	1	1	1
R	5	5	4	-
V	1	2	1	1
W	1	1	2	2

Performance limits (measured at $v = 41 \text{ mm}^2/\text{s}$ and $t = 50 \text{ }^\circ\text{C}$)

The given switching power limits are for applications with two flow directions (e.g. from P to A and simultaneous return flow from B to T).

Due to the flow forces active within the valves the permissible switching power limit may be significantly less if there is only one direction of flow (e.g. from P to A and port B blocked)!

(Please consult us for applications of this kind.)

The switching power limits were measured with the solenoids at operating temperature, 10% under voltage and without tank back pressure.

DC solenoid G24;24V		AC solenoid - W220:220V,50Hz		AC solenoid - 60Hz W220:220V,60Hz	
Char. curve	Symbol	Char. curve	Symbol	Char. curve	Symbol
1	A, B ¹⁾	11	A, B ¹⁾	19	A, B ¹⁾
2	V	12	V	20	V
3	A, B	13	A, B	21	A, B
4	F, P	14	F, P	22	F, P
5	J	15	G, T	23	G, T
6	G, H, T	16	H	24	J,L,U
7	A/O, A/OF, L, U	17	A/O, A/OF, C/O, C/OF	25	A/O, A/OF, Q,W
8	C, D, Y		DO, DOF, E, E ¹⁻²⁾ , J, L	26	C, D, Y
9	M		M, Q, R ³⁾ , U, W	27	H
10	E, E ¹⁻²⁾ , R ³⁾ , C/O C/OF, D/O, D/OF, Q, W	18	C, D, Y	28	C/O, C/OF, D/O, D/OF, E, E ¹⁻²⁾ , M, R ²⁾

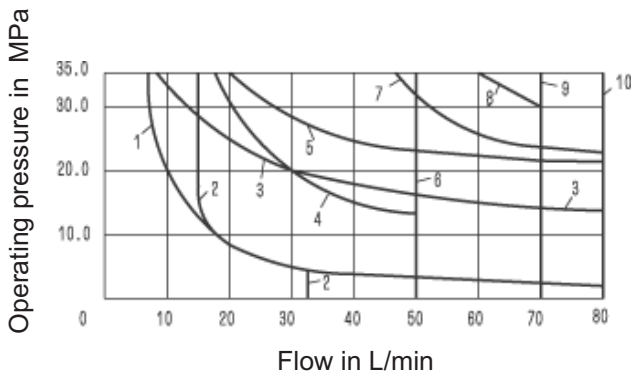

- 1) With hand override
- 2) P → A/B pre-opening
- 3) Return flow from actuator to tank

DC solenoid
Char. curve
1 to 10

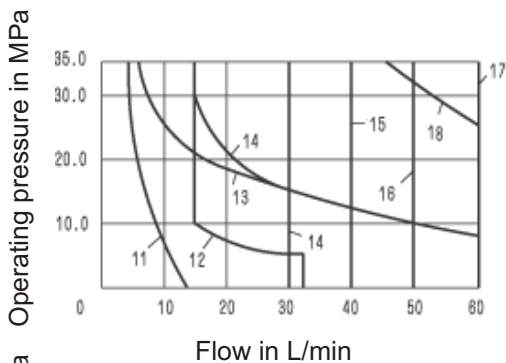

AC solenoid		
Char. curve	Solenoid voltage	
11 to 18	W42	42V, 50Hz
	W110	110V, 50Hz
	W220	220V, 50Hz

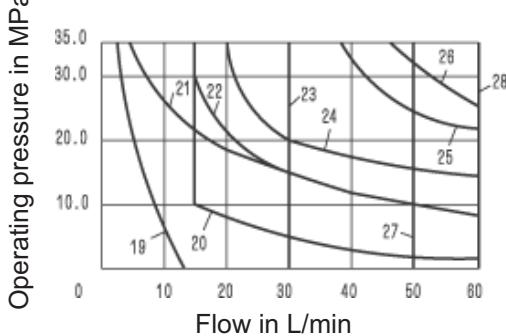

AC solenoid		
Char. curve	Solenoid voltage	
19 to 20	W42	42V, 60Hz
	W110	110V, 60Hz
	W220	220V, 60Hz

Unit dimensions: valve with DC solenoid

Individual connections:

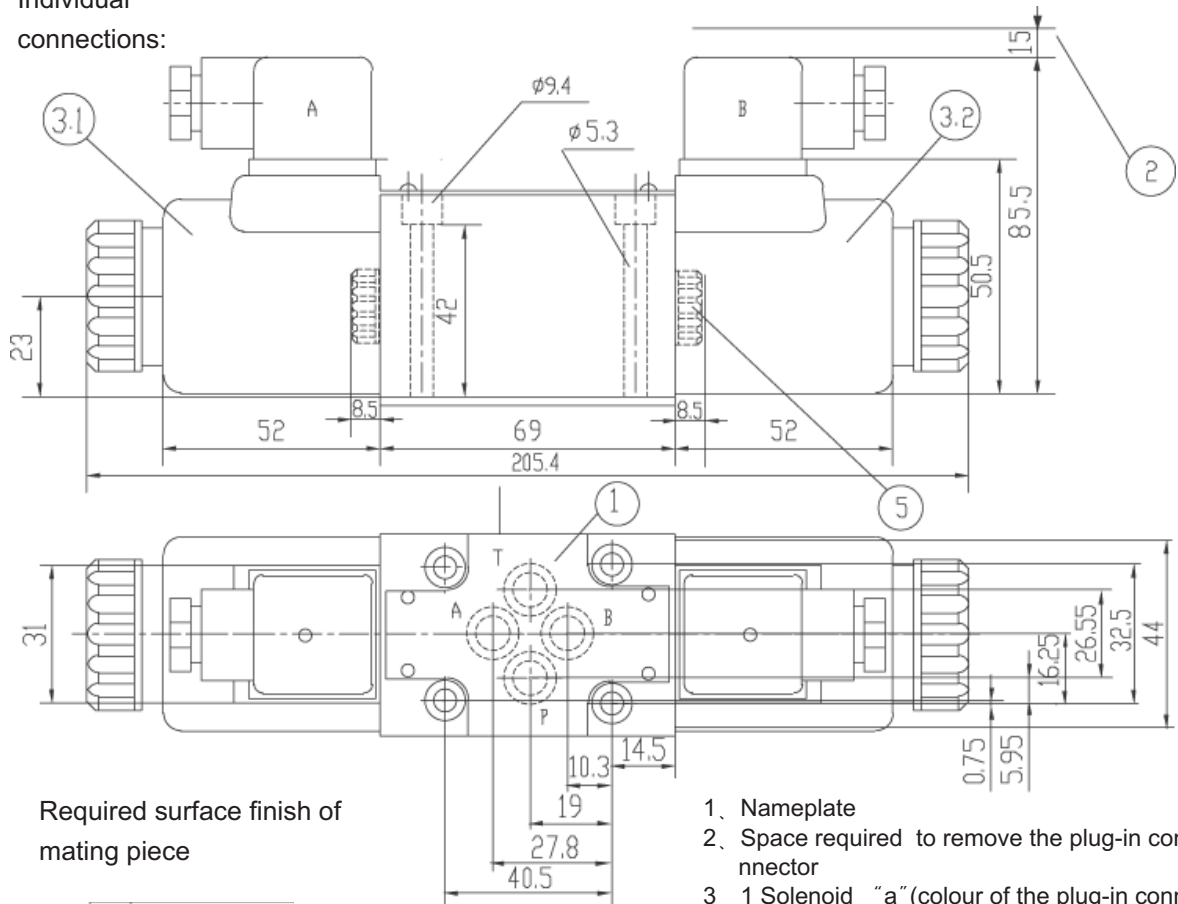

Required surface finish of mating piece

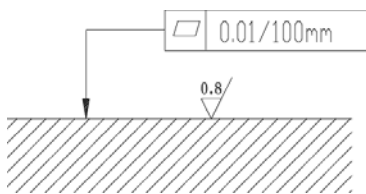

- 1, Nameplate
- 2, Space required to remove the plug-in connector
- 3, 1 Solenoid "a" (colour of the plug-in connector. grey)
- 3, 2 Solenoid "b" (colour of the plug-in connector. black)
- 4, O-ring : 9.25X1.78
- 5, Cover for valve with one solenoid

Central connections:

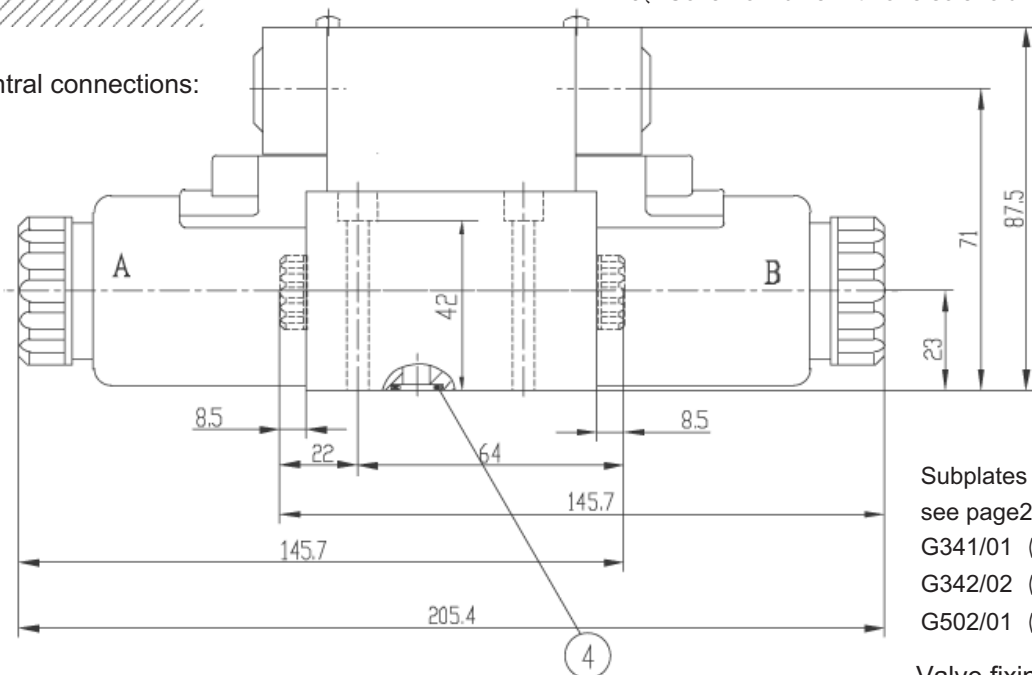

Subplates
see page205
G341/01 (G1/4");
G342/02 (G3/8");
G502/01 (G1/2");

Valve fixing screws
M5X50 -10.9
(GB/T70.1-2000)
 $M_A=8.9Nm$

Unit dimensions: valve with AC solenoid

Individual connections

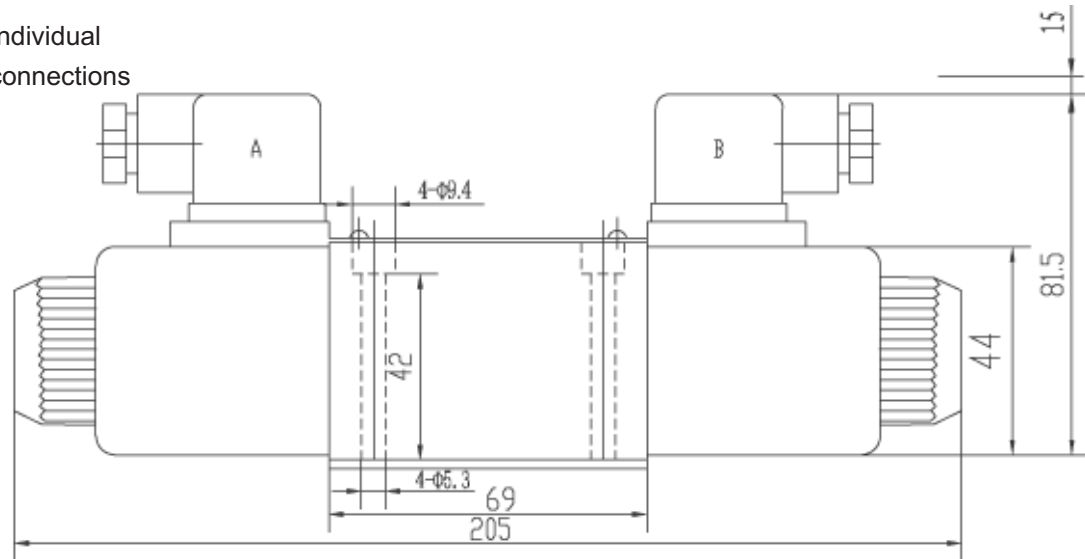

Required surface finish of mating piece

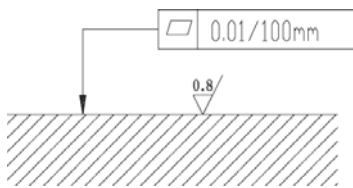

1. Nameplate
2. Space required to remove the plug-in connector
3. 1 Solenoid "a" (colour of the plug-in connector. grey)
3. 2 Solenoid "b" (colour of the plug-in connector. black)
4. O-ring: 9.25X1.78
5. Cover for valve with one solenoid

Central connections:

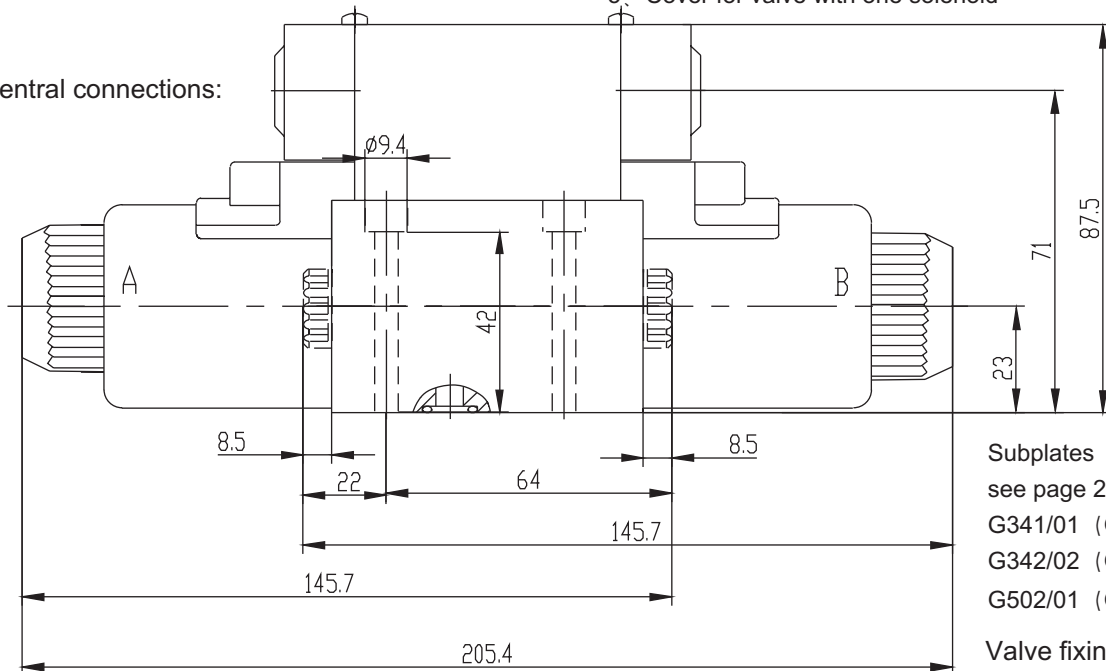

Subplates
see page 205
G341/01 (G1/4");
G342/02 (G3/8");
G502/01 (G1/2");

Valve fixing screws
M5X50 -10.9
(GB/T70.1-2000)
M_A=8.9Nm

Notice

1. The fluid must be filtered. Minimum filter fineness is 20 μm .
2. The tank must be sealed up and an air breather/filter must be installed on air suction/entrance.
3. Subplate are not supplied, if required, please ordering separately.
4. Valve fixing bolts/screws must be high tensile (class 10.9). Please select and consult manufacturer according to the parameter listed in the datasheet.
5. Roughness of surface mating with the valve is required to $\sqrt{0.8}$.
6. Surface straightness of mating piece is required to 0.01/100mm.

All rights reserved-Subject to revision

THM Huade Hydraulics (P) Ltd

F-127, Focal Point, Phase VIII

Ludhiana-141010, India

Phone: 0091+161+2672777, Fax: 0091+161+2672778

www.thmhuade.com

info@thmhuade.com, sales@thmhuade.com